

SEKCIA B

KLZNÉ PODPERY







KLZNÉ DOSKY

NAVAROVACÍ STRMEŇ

STRMENE

VALČEKOVÉ ULOŽENIE

POTRUBNÉ SEDLÁ

					 Macroflex Slovakia sro. Mikovíniho 4 917 01 Trnava www.macroflex.sk	   	+421 33 5936 159 +421 33 5936 237 +421 903 447 575 macroflex@macroflex.sk
0	21/07/10	GENERAL REVISION	DDG	EAR			
REV.	DATE	 pipe hanger solutions	DRAW.	REV.			

OBSAH

- KLZNÉ PODPERY FIG. 2134, 2135, 2136 A 2137.....	B-1
- VARIANTY KLZNÝCH PODPIER	B-6
- PTFE KLZNÉ DOSKY FIG. 2138	B-12
- SFÉRICKÉ PTFE KLZNÉ DOSKY FIG. 2138	B-14
- BRONZO-GRAFITOVÉ KLZNÉ DOSKY FIG. 2139	B-15
- SFÉRICKÉ BRONZO-GRAFITOVÉ KLZNÉ DOSKY FIG. 2139	B-17
- NAVAROVACÍ STRMEŇ Z PLOCHEJ TYČE FIG. 2250, 2251 A 2252	B-18
- STRMENE FIG. 2280 A 2281	B-22
- VALČEKOVÉ ULOŽENIE FIG. 2297	B-24
- POTRUBNÉ SEDLÁ FIG. 2300-2310	B-25

0	21/07/10	GENERAL REVISION	DDG	EAR
REV.	DATE		DRAW.	REV.

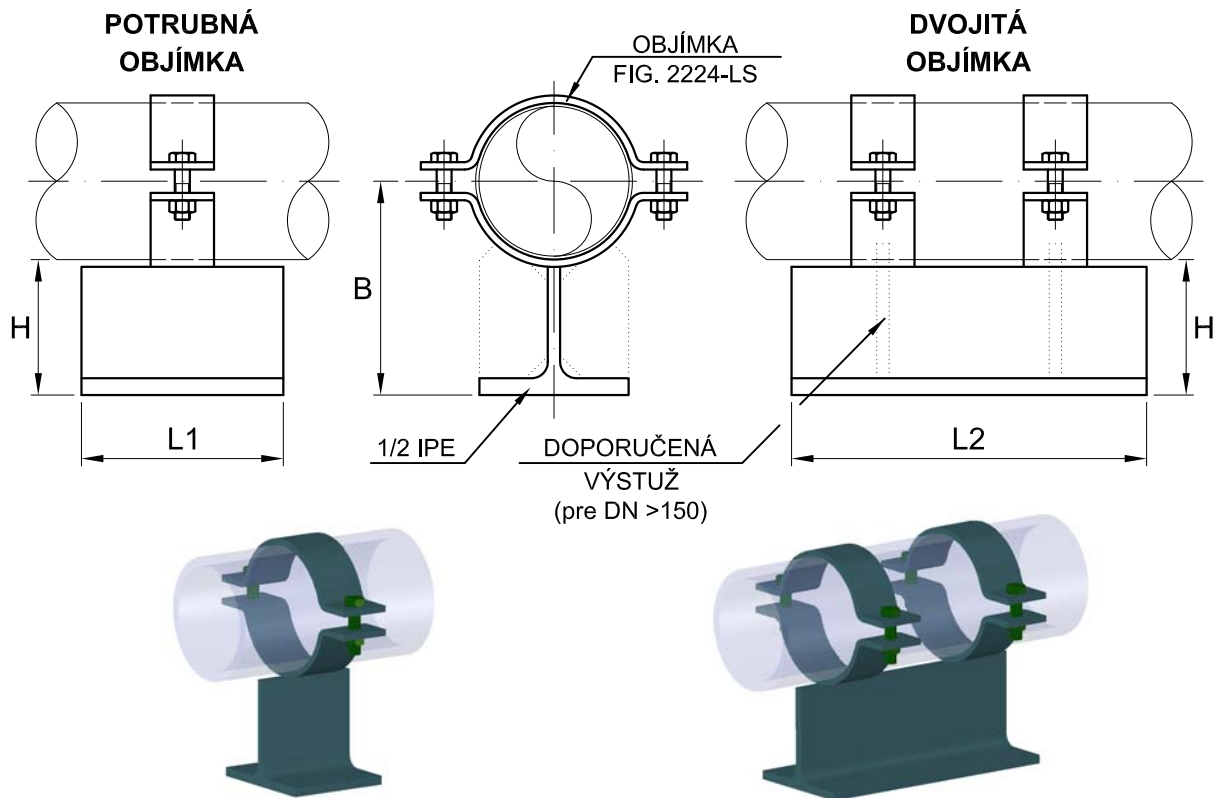

PIPE D.N.	B (mm)				L1 (mm)	L2 (mm)	MAX. DOPORUČENÉ ZATAŽENIE (kN)
	IPE 160	IPE 200	IPE 240	IPE 270			
15	93	113	-	-	100	200	2,45
20	96	116	-	-	100	200	2,45
25	99	119	-	-	100	200	2,45
32	103	123	-	-	100	200	2,45
40	108	128	-	-	100	200	3,43
50	114	134	-	-	150	200	3,43
65	121	141	-	-	150	250	3,92
80	129	149	169	-	150	250	4,9
100	141	161	181	-	150	250	4,9
125	-	175	195	210	150	250	6,37
150	-	190	210	225	150	300	11,27
200	-	216	236	251	150	300	11,27
250	-	245	265	280	150	300	13,72
300	-	270	290	305	-	350	16,17
350	-	288	308	323	-	350	19,11
400	-	313	333	348	-	400	19,11
450	-	339	359	374	-	400	22,05
500	-	367	387	402	-	400	25,97

POUŽITIE: klzné podpery slúžia ako klzné uloženie alebo vedenie pre menšie horizontálne zaťaženia. Sú určené pre potrubné vedenia s aj bez izolácie v prevedení s axiálnym vedením, v spojení s klznými doskami alebo aj na prenos momentových zložiek zaťaženia.

OBJEDNÁVANIE:

- názov
- Fig. a typ objímky (jednoduchá/dvojitá)
- priemer potrubia
- rozmer "B" alebo "H"
- dĺžka "L" ak sa odlišuje od štandardu
- alternatíva "G" ak majú byť objímky pootočené alebo "SS" ak zákl. doska má byť z nerezovej ocele.

MATERIÁL: uhlíková alebo legovaná oceľ, v prípade legovanej ocele "T" segmenty sú opatrené výstužou.

POZN.: pre potrubia z nerezovej ocele objímky z nehrdzavejúcej ocele, uhlíkovej/legovanej ocele s vložkami z nehrdzavejúcej ocele alebo gummy na zabránenie kontaktu plôch potrubia a objímky.

POZN.: podpery je možné dodať aj v iných rozmeroch než aké sú uvedené, potrubné objímky môžu byť pootočené v 30° až 45° uhle. Na zabezpečenie nižšieho koeficientu trenia je možné základovú dosku opatriť klzným plechom z nehrdzavejúcej ocele (2 mm) pre použitie s PTFE klznými doskami..

3	21/07/10	GENERAL REVISION	DDG	EAR
2	20/10/98	INFORMATION	JB	EAR
1	20/05/91	INFORMATION	FG	EAR
REV.	DATE		DRAW.	REV.



Macroflex Slovakia sro. ☎ +421 33 5936 159
 Mikovíniho 4 ☎ +421 33 5936 237
 917 01 Trnava ☎ +421 903 447 575
 www.macroflex.sk ✉ macroflex@macroflex.sk

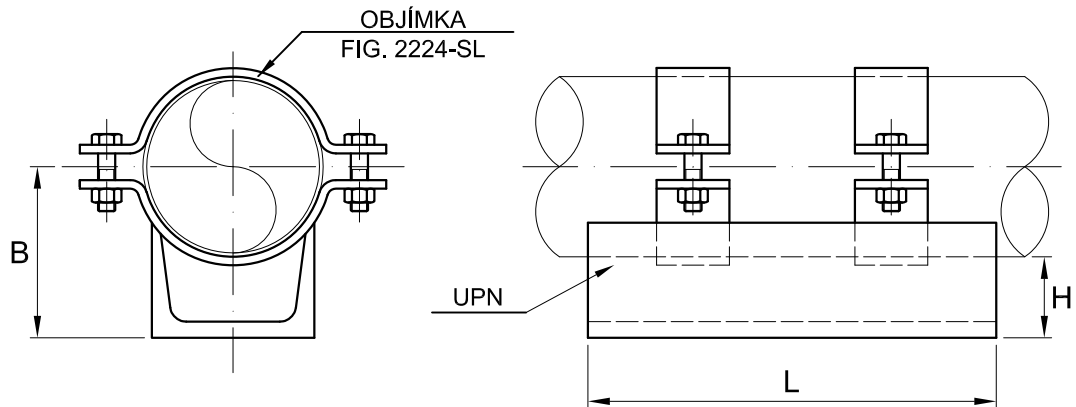

DN	UPN	B (mm)	L (mm)	MAX. DOPORUČENÉ ZAŤAŽENIE (kN)
50	60	53	200	40,0
65	80	60	250	55,0
80	80	77	250	55,0
100	100	89	250	75,0
125	100	109	250	75,0
150	120	125	300	100,0
200	140	155	300	150,0
250	140	189	300	150,0
300	160	217	350	205,0
350	160	237	350	205,0
400	200	265	400	325,0
450	200	282	400	325,0
500	240	326	400	450,0



POUŽITIE: klzné podpery slúžia ako klzné uloženia alebo vedenie pre menšie horizontálne zaťaženia. Sú určené pre potrubné vedenia s aj bez izolácie v prevedení s axiálnym vedením, v spojení s klznými doskami alebo aj na prenos momentových zložiek zaťaženia.

OBJEDNÁVANIE:

- Názov.
- Fig. a typ objímky (jednoduchá/dvojitá)
- Priemer potrubia.
- Výška "B" or "H".
- Dĺžka "L" ak sa odlišuje od štandardu.
- Alternatíva "G" ak majú byť objímky pootočené "SS" ak zákl.doska má byť z nehrdzavejúcej ocele.

MATERIÁL: uhlíková alebo legovaná oceľ, v prípade legovanej ocele sú "T" segmenty opatrené výstužou.

POZNÁMKA.: pre potrubia z nehrdzavejúcej ocele, objímky z nehrdzavejúcej ocele, uhlíkovej/legovanej ocele s vložkami z nehrdzavejúcej ocele alebo gummy na zabránenie kontaktu plôch potrubia a objímky. Podpery je možné dodať aj v iných rozmeroch než sú uvedené, potrubné objímky môžu byť pootočené v 30° až 40° uhle. Na zabezpečenie nižšieho koeficientu trenia je možné základovú dosku opatřit klzným plechom z nehrdzavejúcej ocele (2mm) pre použitie s PTFE klznými doskami.

3	21/07/10	GENERAL REVISION	DDG	EAR
2	20/10/98	INFORMATION	JB	EAR
1	20/05/91	INFORMATION	FG	EAR
REV.	DATE		DRAW.	REV.



Macroflex Slovakia sro. ☎ +421 33 5936 159
 Mikovíniho 4 ☎ +421 33 5936 237
 917 01 Trnava ☎ +421 903 447 575
 www.macroflex.sk ✉ macroflex@macroflex.sk

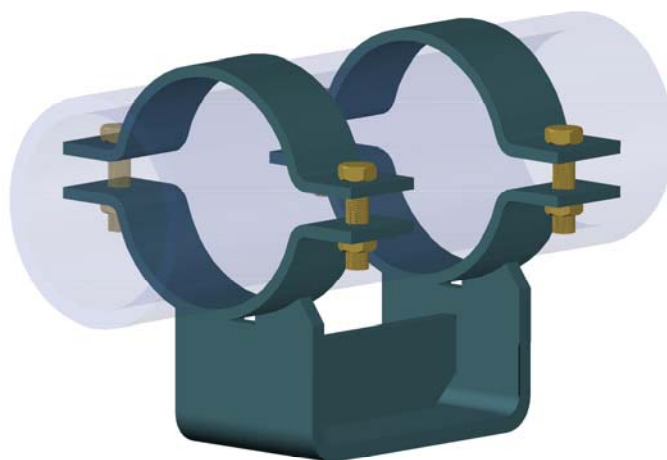
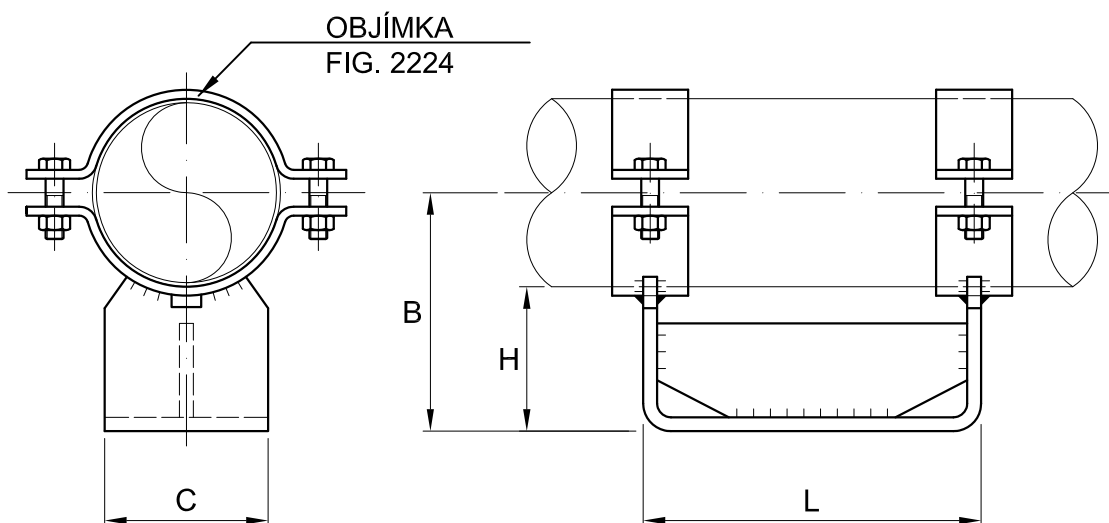

POUŽITIE: klzné podpery slúžia ako uloženie alebo vedenie potrubia s menším horizontálnym zaťažením. Sú určené pre potrubné vedenia s aj bez izolácie v prevedení s axiálnym vedením v spojení s klznými doskami alebo aj na prenos momentových zložiek zaťaženia. Môžu byť použité ako vedenie zabraňujúce laterálnym pohybom vo viacerých osiach.

OBJEDNÁVANIE:

- Názov.
- Fig. a typ objímky (Jednoduchá/Dvojitá)
- Priemer potrubia.
- Výška "B" alebo "H".
- Dĺžka "L" ak sa odlišuje od štandardu.
- Alternatíva "G" ak majú byť objímky pootočené alebo "SS" ak základová doska má byť z nehrdzavejúcej ocele.
- Možnosť vedenia vo viacerých osiach.

MATERIAL:

Uhlíková alebo legovaná oceľ.

TABUĽKA ROZMEROV NA STRANE B-9

3	21/07/10	GENERAL REVISION	DDG	EAR
2	20/10/98	INFORMATION	JB	EAR
1	20/05/91	INFORMATION	FG	EAR
REV.	DATE	 pihasa pipe hanger solutions	DRAW.	REV.



Macroflex Slovakia sro. ☎ +421 33 5936 159
 Mikovíniho 4 ☎ +421 33 5936 237
 917 01 Trnava ☎ +421 903 447 575
 www.macroflex.sk ✉ macroflex@macroflex.sk

DN	B (mm)			C (mm)	L (mm)	MAX. DOPORUČENÉ ZAŤAŽENIE (kN)			
						PREV.1	PREV.2	PREV.3	PREV.4
50	130	180	230	70	200	57,5	-	-	-
65	137	187	237	80	250	65,0	-	-	-
80	144	194	244	100	250	75,0	110,0	-	-
100	157	207	257	110	250	80,0	125,0	-	-
125	170	220	270	130	250	90,0	135,0	-	-
150	184	234	284	150	300	125,0	160,0	235,0	-
200	210	260	310	175	300	150,0	200,0	275,0	-
250	237	287	337	200	300	200,0	350,0	450,0	-
300	262	312	362	230	350	250,0	325,0	475,0	650,0
350	278	328	428	250	350	275,0	390,0	500,0	715,0
400	303	403	453	280	400	-	415,0	575,0	725,0
450	329	429	529	300	400	-	450,0	600,0	750,0
500	354	454	554	315	400	-	510,0	650,0	880,0
550	380	480	580	325	450	-	540,0	720,0	945,0
600	455	505	605	340	450	-	625,0	750,0	1015,0
650	480	530	630	360	450	-	650,0	795,0	1050,0
700	506	556	656	375	450	-	-	850,0	1125,0
750	531	581	681	400	450	-	-	910,0	1180,0
800	556	606	706	425	500	-	-	950,0	1240,0
850	607	657	757	440	500	-	-	1005,0	1295,0

POZNÁMKA.: podpery je možné dodať aj v iných rozmeroch než uvedené. Tieto môžu byť pootočené v 30° alebo 45° uhle. Pri potrubných uloženiach s vyššou prevádzkovou teplotou, je treba vziať do úvahy korekčný teplotný faktor, ako u uhlíkovej ocele tak aj u legovanej ocele.

Vid' tabuľku na strane A-20.

Na zabezpečenie nižšieho koeficientu trenia je možné základovú dosku opatriť klzným plechom z nehrdzavejúcej ocele (2 mm s povrchovou úpravou 2B).

Pre potrubia a objímky z nehrdzavejúcej ocele, uhlíkovej/legovanej ocele s vložkami z nehrdzavejúcej ocele alebo gumy na zabránenie kontaktu plôch potrubia a objímky.

3	21/07/10	GENERAL REVISION	DDG	EAR
2	20/10/98	INFORMATION	JB	EAR
1	20/05/91	INFORMATION	FG	EAR
REV.	DATE		DRAW.	REV.

 **pihasa**
pipe hanger solutions

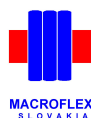

Macroflex Slovakia sro.
Mikovíniho 4
917 01 Trnava
www.macroflex.sk



+421 33 5936 159
+421 33 5936 237
+421 903 447 575
macroflex@macroflex.sk

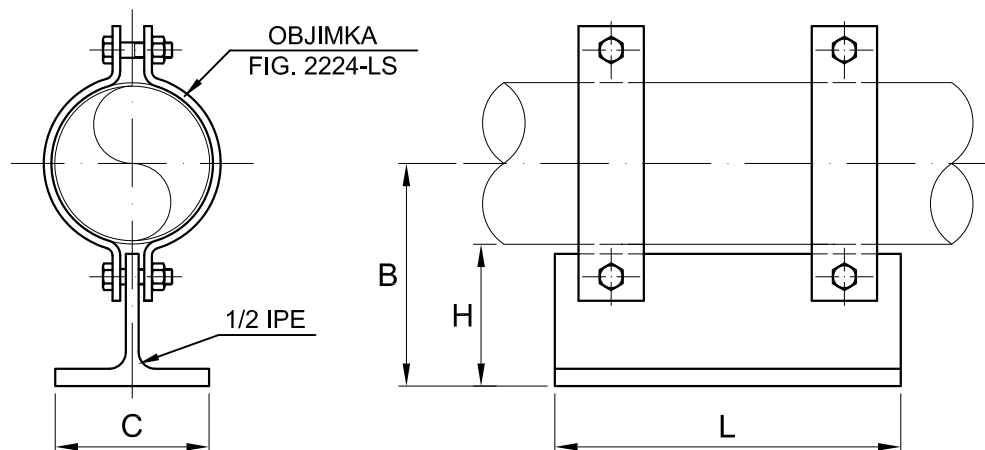

DN	B (mm)				L (mm)	MAX. DOPORUČENÉ ZAŤAŽENIE (kN)
	IPE-160	IPE-200	IPE-240	IPE-270		
15	95	115	-	-	200	25,0
20	98	118	-	-	200	25,0
25	101	121	-	-	200	25,0
32	105	125	-	-	200	25,0
40	107	127	-	-	200	35,0
50	113	133	153	-	200	45,0
65	121	141	161	-	250	50,0
80	129	149	169	-	250	50,0
100	138	158	178	-	250	50,0
125	-	173	193	208	250	65,0
150	-	191	211	226	300	75,0
200	-	217	237	252	300	75,0
250	-	243	263	278	300	85,0
300	-	269	289	304	350	95,0

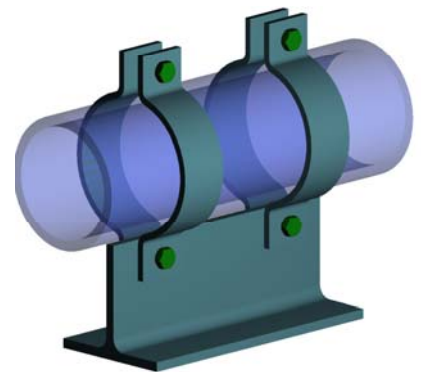

POUŽITIE: klzne podpery slúžia ako klzne uloženie alebo ako vedenie pre menšie horizontálne zaťaženia. Sú určené pre potrubne vedenia s aj bez izolácie. Môže byť použité ako vedenie zabranujúce laterálnym pohybom vo viacerých osiach.



OBJEDNÁVANIE:

- názov.
- Fig. a typ objímky (jednoduchá/dvojitá).
- priemer potrubia.
- výška "B" or "H".
- dĺžka "L" ak sa odlišuje od štandardu

MATERIAL: uhlíková oceľ.

3	21/07/10	GENERAL REVISION	DDG	EAR
2	20/10/98	INFORMATION	JB	EAR
1	20/05/91	INFORMATION	FG	EAR
REV.	DATE		DRAW.	REV.



Macroflex Slovakia sro.  +421 33 5936 159
 Mikovíniho 4  +421 33 5936 237
 917 01 Trnava  +421 903 447 575
 www.macroflex.sk  macroflex@macroflex.sk

180° VEDENIE

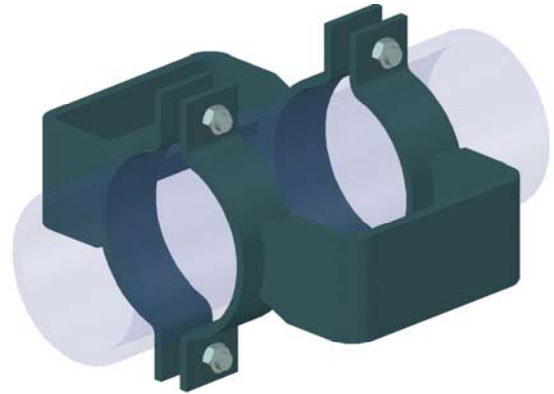
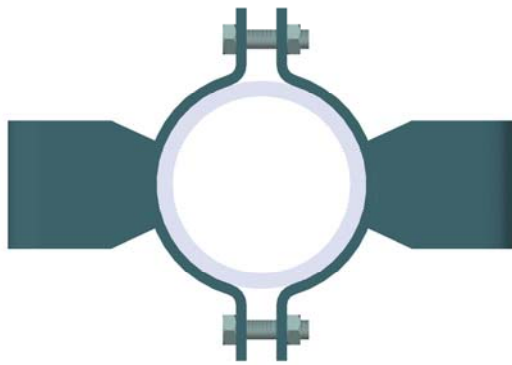

Klzná podpera s vedením pre vertikálne a laterálne zaťaženie v oboch smeroch
Fig. 2136 180° dvojité objímka.

90° VEDENIE

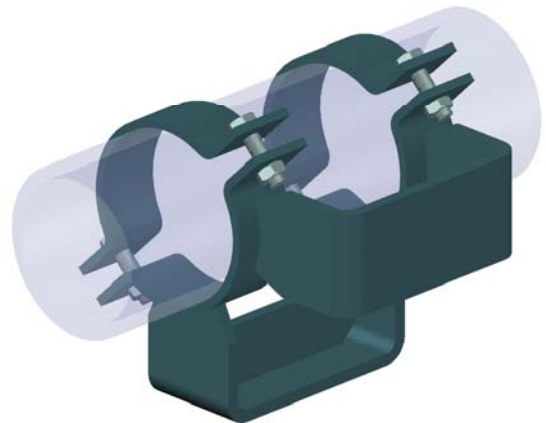

Klzná podpera s vedením pre vertikálne a laterálne zaťaženie v jednom smere
Fig. 2136 90° dvojité objímka.

0	21/07/10	GENERAL REVISION	DDG	EAR
REV.	DATE	 pihasa pipe hanger solutions	DRAW.	REV.



Macroflex Slovakia sro.
Mikovíniho 4
917 01 Trnava
www.macroflex.sk



+421 33 5936 159
+421 33 5936 237
+421 903 447 575
macroflex@macroflex.sk

270° VEDENIE

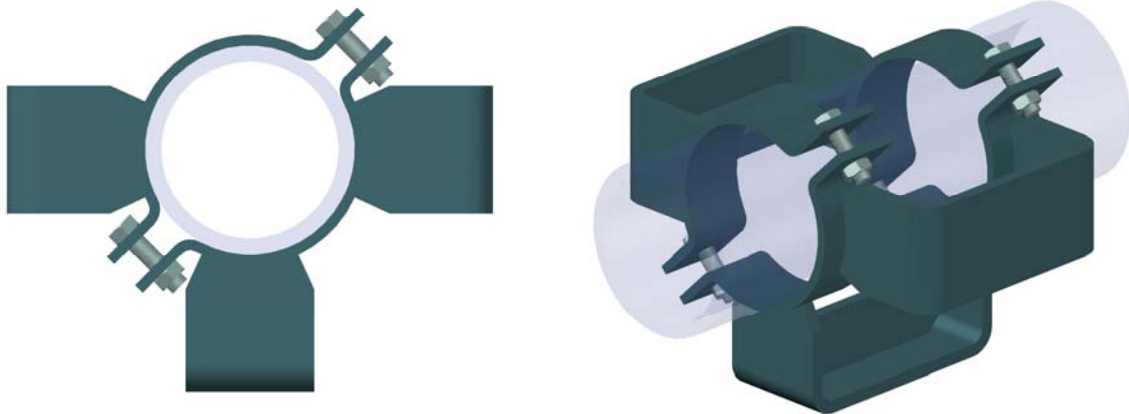





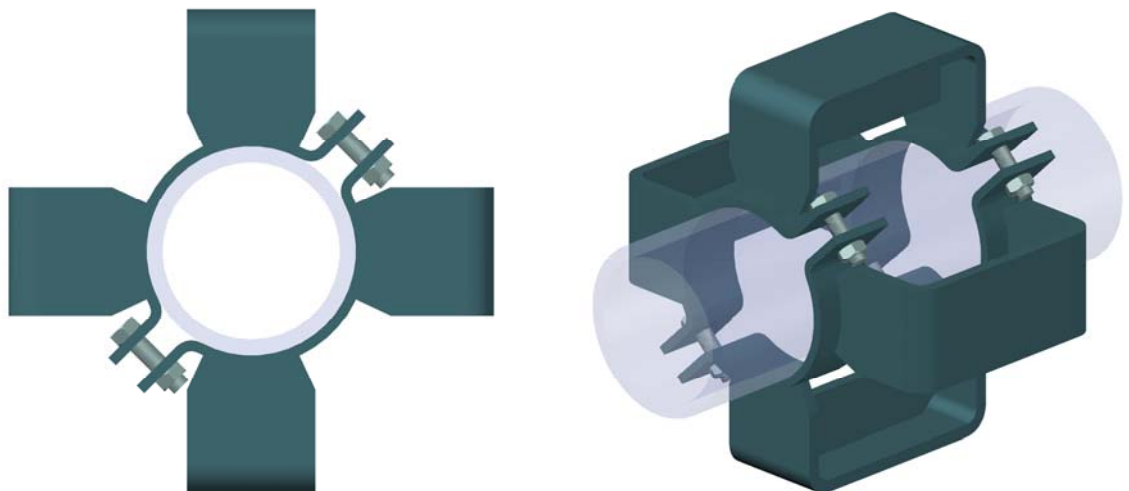

Klzná podpera pre vertikálne a laterálne zaťaženie v oboch osiach.
Fig. 2136 dvojitá objímka s vedením v troch smeroch

360° VEDENIE



Klzná podpera s vedením v obidvoch osiach a smeroch
Fig. 2136 dvojitá objímka s 360° vedením

0	21/07/10	GENERAL REVISION	DDG	EAR	
REV.	DATE	 pihasa pipe hanger solutions	DRAW.	REV.	
				 Macroflex Slovakia sro. Mikovíniho 4 917 01 Trnava www.macroflex.sk  +421 33 5936 159  +421 33 5936 237  +421 903 447 575  macroflex@macroflex.sk	

Klzná podpera pre axiálne zaťaženie

- S OBMEDZOVAČMI POHYBU NA POTRUBÍ

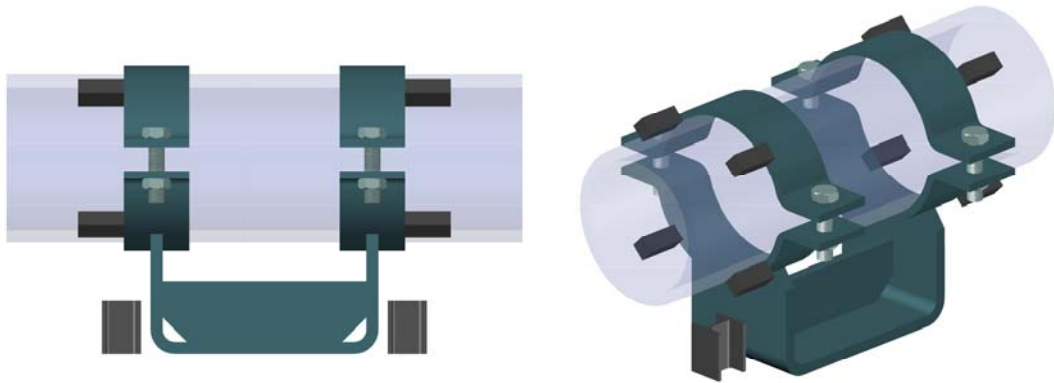

Fig. 2136 s dorazmi v axiálnom smere - varianta 1

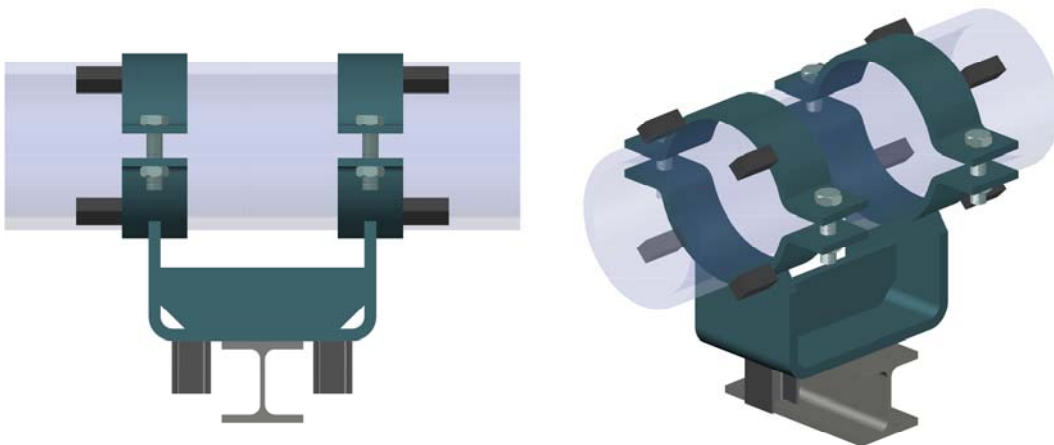







Fig. 2136 s dorazmi v axiálnom smere - varianta 2

POZNÁMKA.: rozmery dorazov sú závislé od axiálneho zaťaženia.

					 Macroflex Slovakia sro. Mikovíniho 4 917 01 Trnava www.macroflex.sk	 +421 33 5936 159  +421 33 5936 237  +421 903 447 575  macroflex@macroflex.sk
0	21/07/10	GENERAL REVISION	DDG	EAR		
REV.	DATE	 pihasa pipe hanger solutions	DRAW.	REV.		

Klzná podpera pre axiálne zaťaženie

- S TRUNNIONOM NA POTRUBÍ

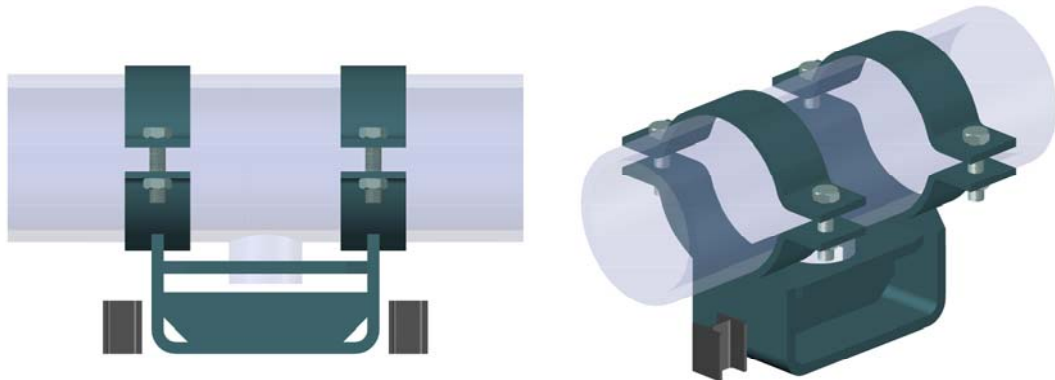

Fig. 2136 s trunnionom na potrubí a obmedzovačmi v axiálnom smere - varianta 1

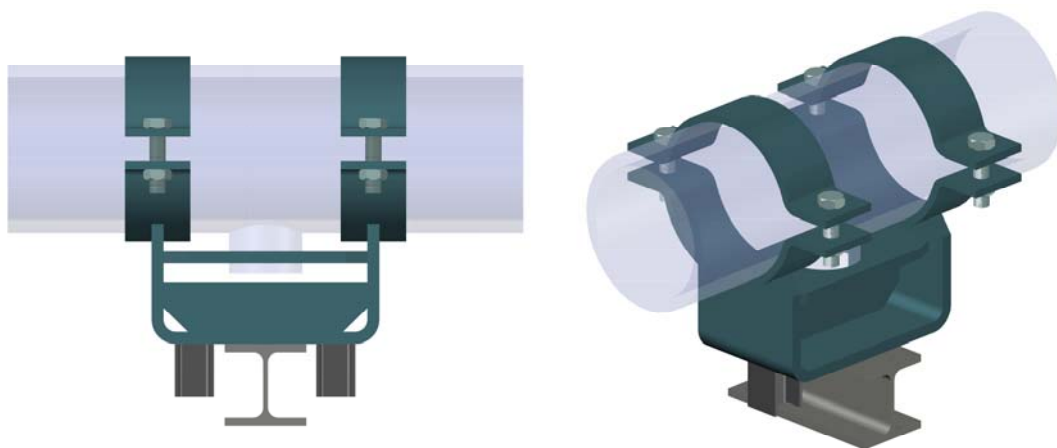







Fig. 2136 s trunnionom na potrubí a obmedzovačmi s axiálnom smere - varianta 2

POZNÁMKA: rozmery trunnionu a dorazov sú závislé od axiálneho zaťaženia.

0	21/07/10	GENERAL REVISION	DDG	EAR	
REV.	DATE	 pihasa pipe hanger solutions	DRAW.	REV.	 <p>Macroflex Slovakia sro.  +421 33 5936 159 Mikovíniho 4  +421 33 5936 237 917 01 Trnava  +421 903 447 575 www.macroflex.sk  macroflex@macroflex.sk</p>

Klzné podpery s obmedzovačmi pohybu

- S DORAZMI NA POTRUBÍ A VEDENÍM

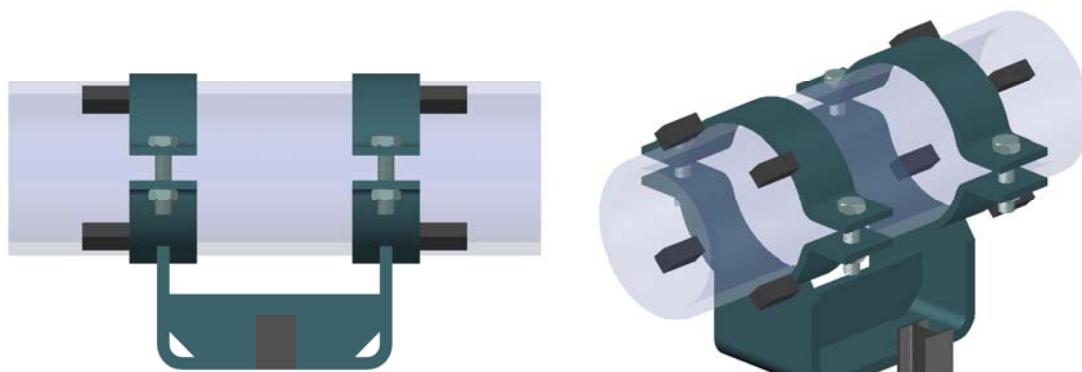

Fig. 2136 klzne podpery s obmedzovačmi na potrubí a axiálnym vedením

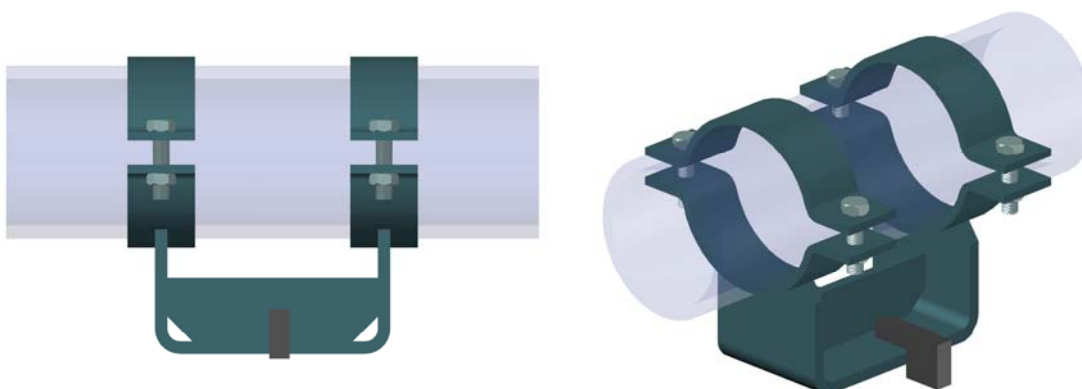







Fig. 2136 klzné podpery s axiálnym vedením a obmedzovačmi pohybu vo zvislej osi

POZNÁMKA: rozmery vedenia a obmedzovačov sú závislé od zaťaženia

0	21/07/10	GENERAL REVISION	DDG	EAR	
REV.	DATE	 pihasa pipe hanger solutions	DRAW.	REV.	
				 Macroflex Slovakia sro.  +421 33 5936 159 Mikovíniho 4  +421 33 5936 237 917 01 Trnava  +421 903 447 575 www.macroflex.sk  macroflex@macroflex.sk	

Klzné podpery s obmedzovačmi pohybu

- S TRUNNIONOM NA POTRUBÍ

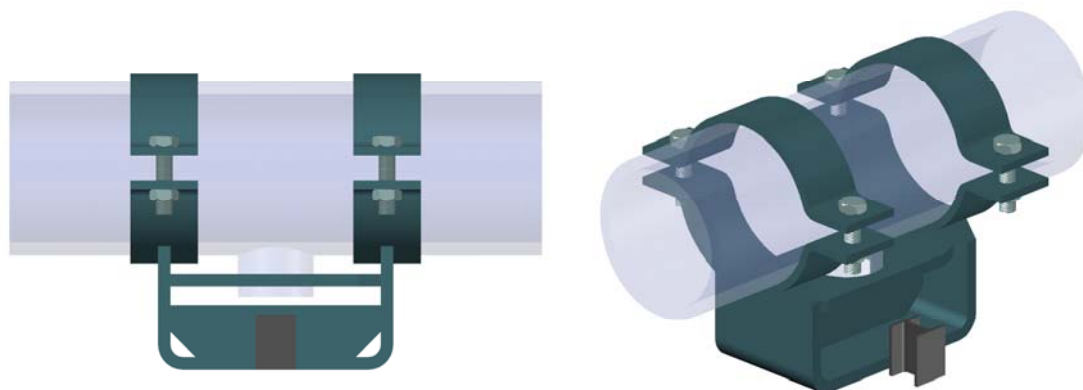

Fig. 2136 klzne podpery s trunnionom na potrubí a axiálnym vedením

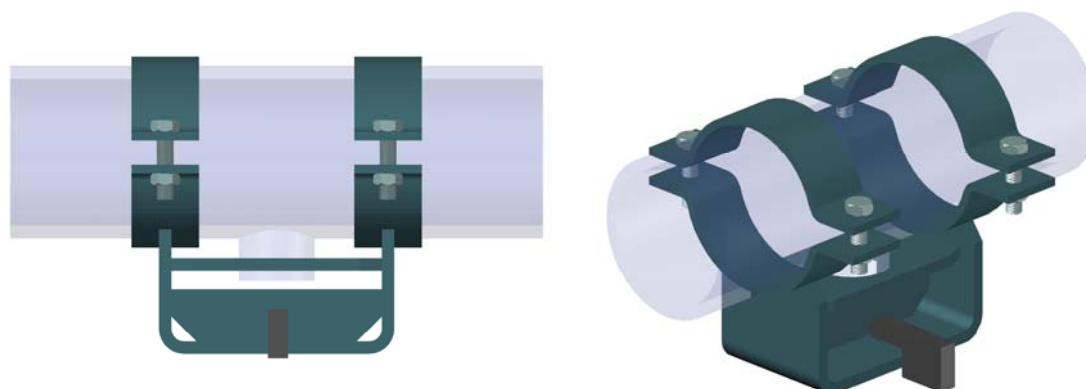

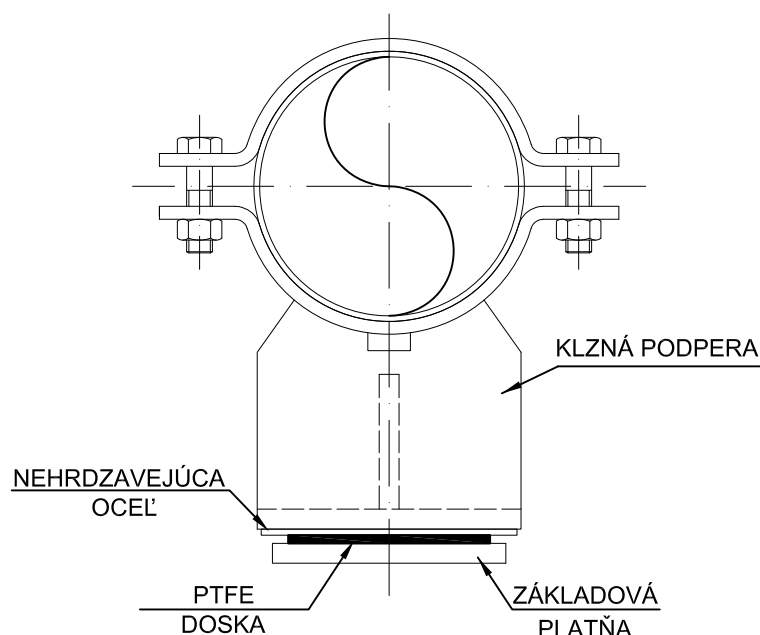

Fig. 2136 s trunnionom, axiálnym vedením a blokovaním pohybu vo vertikálnej osi

POZNÁMKA: rozmery trunnionu, dorazov a obmedzovačov sú závislé od zaťaženia

0	21/07/10	GENERAL REVISION	DDG	EAR	
REV.	DATE	 pihasa pipe hanger solutions	DRAW.	REV.	
			Macroflex Slovakia sro. Mikovíniho 4 917 01 Trnava www.macroflex.sk		☎ +421 33 5936 159 ☎ +421 33 5936 237 ☎ +421 903 447 575 ✉ macroflex@macroflex.sk



POUŽITIE: vhodné v spojení s klznými podperami. Bežne sú uchytené na rôzne typy základových dosiek alebo do záťažovej dosky pružinovej podpery (typ F). Maximálna odporúčaná teplota pri trvalom kontakte je 120°C.

MONTÁŽ: PTFE doska môže byť osadená na základovej platni rôznych rozmerov. Medzi PTFE a záťažovou doskou je leštený plech z nehrdzavejúcej ocele (povrchová úprava 2B)



VLASTNOSTI:

- nízky koeficient trenia.
- chemická odolnosť.
- odolné voči nečistotám.
- chemicky stabilné v rozmedzí -180°C až +280°C
- odolnosť voči krehkosti od vysokých po nízke teploty
- maximálne pracovné zaťaženie: 10MPa

OBJEDNÁVANIE:

- Názov.
- Fig.č
- Rozmery alebo číslo.

POZNÁMKA: rozmery a tvar je možné prispôbiť na základe konkrétnych požiadaviek. Uvedené katalógové rozmery a typy sú reprezentatívnou vzorkou, ktorá môže byť upravená podľa požiadaviek zákazníka a konkrétnej konštrukcie.

1	21/07/10	GENERAL REVISION	DDG	EAR	 <p>Macroflex Slovakia sro. Mikovíniho 4 917 01 Trnava www.macroflex.sk</p> <p>☎ +421 33 5936 159 ☎ +421 33 5936 237 ☎ +421 903 447 575 ✉ macroflex@macroflex.sk</p>
0	21/09/81	INFORMATION	JRS	EAR	
REV.	DATE	 <p>pihasa pipe hanger solutions</p>	DRAW.	REV.	

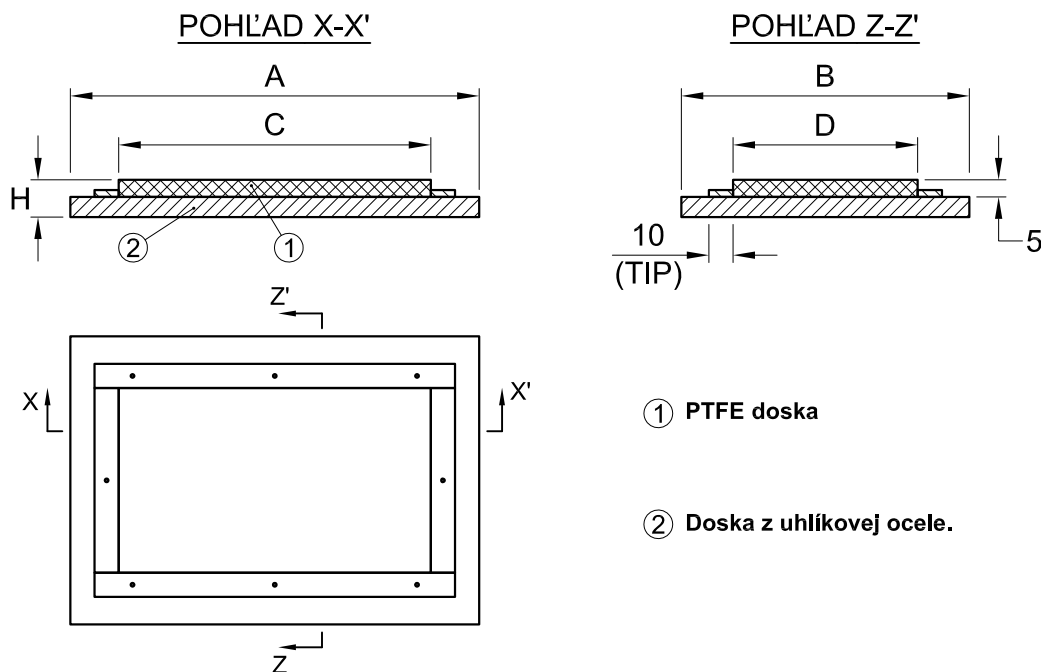

veľkosť	A (mm)	B (mm)	C (mm)	D (mm)	H (mm)	doporučené zaťaženie (kN)
01	80	80	50	50	13	12,50
02	105	80	75	50	13	18,75
03	130	80	100	50	13	25,00
04	165	80	125	50	13	31,25
05	180	80	150	50	13	37,50
06	105	105	75	75	13	28,10
07	130	105	100	75	13	37,50
08	180	105	150	75	13	52,65
09	230	105	200	75	13	75,00
10	130	130	100	100	13	50,00
11	180	130	150	100	13	75,00
12	230	130	200	100	13	100,00
13	280	130	250	100	13	125,00
14	330	130	300	100	13	150,00
15	180	180	150	150	15	112,50

veľkosť	A (mm)	B (mm)	C (mm)	D (mm)	H (mm)	doporučené zaťaženie (kN)
16	230	180	200	150	15	150,00
17	280	180	250	150	15	187,50
18	330	180	300	150	15	225,00
19	430	180	400	150	15	300,00
20	230	230	200	200	15	200,00
21	330	230	300	200	15	300,00
22	430	230	400	200	15	400,00
23	280	280	250	250	15	312,50
24	330	280	300	250	15	375,00
25	430	280	400	250	15	500,00
26	530	280	500	250	15	625,00
27	330	330	300	300	15	450,00
28	430	330	400	300	15	600,00
29	530	330	500	300	15	750,00
30	430	430	400	400	15	800,00

POZNÁMKA:

- štandardne sa dodáva s lešteným plechom z nehrdzavejúcej ocele z úpravou 2B. Rozmery plechu z nehrdzavejúcej ocele sú závislé od veľkosti PTFE dosky a pohybu.
- rovnako je možné použiť ďalšiu PTFE dosku s mazaným povrchom, ktorá znižuje koeficient trenia na 0,05.
- môže byť vyrobená v rôznych veľkostiach ako základová doska tak aj PTFE, tá však s minimálnou hrúbkou 8mm.
- pracovná teplota by nemala presiahnuť 120°C.
- Doplnky:
 - dosky môžu byť vybavené obmedzovacími pohybom.
 - valcové alebo sférické podložky umožňujúce nakláňanie.
 - špeciálne doplnky podľa požiadaviek zákazníka.

REV.	DATE		DRAW.	REV.
1	21/07/10	GENERAL REVISION	DDG	EAR
0	20/10/98	INFORMATION	JB	EAR
				



Macroflex Slovakia sro.  +421 33 5936 159
 Mikovíniho 4  +421 33 5936 237
 917 01 Trnava  +421 903 447 575
 www.macroflex.sk  macroflex@macroflex.sk

PTFE KLZNÁ DOSKA SFÉRICKÁ

FIG.: 2138
SPH

SEKCIA B
14

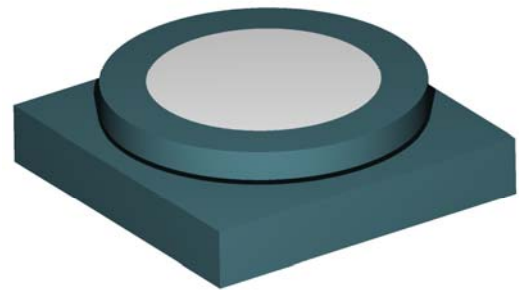
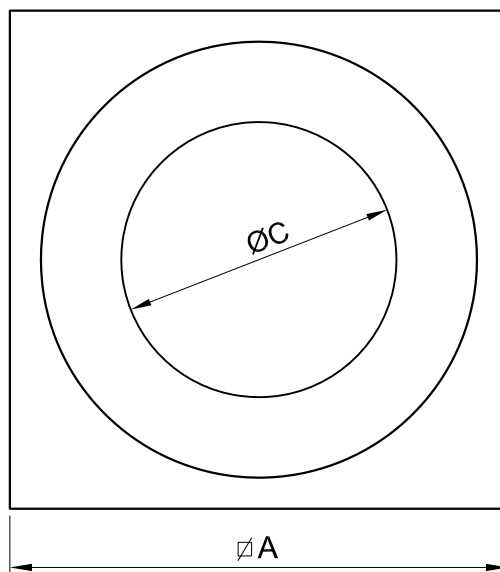
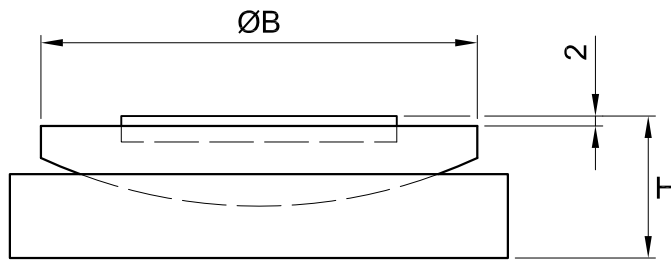

No.	ØA (mm)	ØB (mm)	ØC (mm)	H (mm)	MAX. ZAŤAŽENIE (kN)
1	90	80	50	32	9,75
2	115	105	75	35	22,00
3	140	130	100	38	39,00
4	160	150	120	37	56,50
5	190	180	150	44	88,25
6	220	210	200	44	157,00

POZNÁMKA:

- maximálny náklon $\pm 2^\circ$ vo všetkých smeroch.
- podľa požiadavky môže byť náklon väčší, avšak na úkor rozmerov

0	21/07/10	GENERAL REVISION	DDG	EAR
REV.	DATE	pihasa pipe hanger solutions	DRAW.	REV.



Macroflex Slovakia sro.
Mikovániho 4
917 01 Trnava
www.macroflex.sk



+421 33 5936 159
+421 33 5936 237
+421 903 447 575
macroflex@macroflex.sk

BRONZO-GRAFITOVÉ KLZNÉ DOSKY

FIG.: 2139

SEKCIA B
15

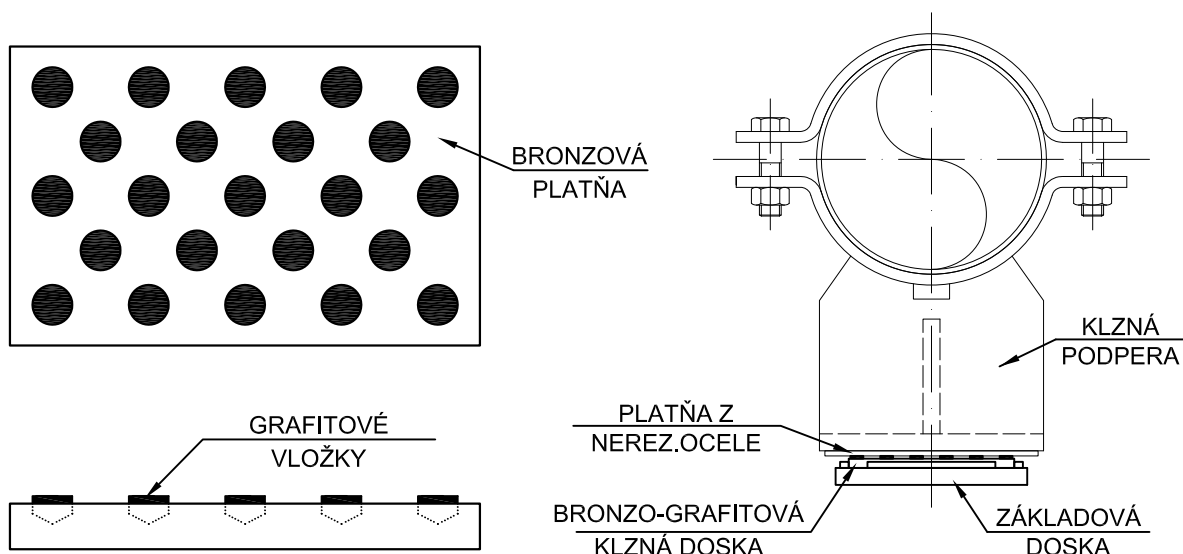

MATERIÁL: klzná doska je bronzová zliatina s malým množstvom prídavných materiálov (Pb, Zn, atď.) Ako klzný prvok je použitý grafit vo forme vložíek.

POUŽITIE: sú určené pre kompletizácie ložiskových stojanov, pre pohybujúce sa zariadenia s malou pohybovou rýchlosťou, pracujúce pri vysokých prevádzkových teplotách. Vysoká nosnosť a odolnosť voči oteru.

MONTÁŽ: bronzografitové dosky sú dodávané na základovej doske. Protikus klznej dosky je opatrený plechom z nehrdzavejúcej ocele. Pokiaľ dodávka nezahrňuje celú zostavu aj s hornou nerezovou doskou, pre správnu funkciu je potrebné nerezovú dosku doplniť.



TVARY: tieto podpery môžu byť dodávané v rôznych tvaroch

- štvorcová alebo obdĺžniková platňa
- okrúhla platňa
- púzdro
- rotačný kĺb

VLASTNOSTI: podstatnou vlastnosťou je jeho nízky koeficient trenia:

- trecí koeficient pre vysoké zaťaženia 0.04 - 0.08.
- trecí koeficient pre nízke zaťaženia 0.09 - 0.1.
- rýchlosť posuvu nesmie presiahnuť 2,5 m/s
- maximálne pracovné zaťaženie je 15 MPa.
- teplotné rozmedzie je veľmi široké a dosahuje vysoké hodnoty (600°C)

OBJEDNÁVANIE: podľa požiadaviek zákazníka, poprípade navrhne a doporučíme úpravy

1	21/07/10	GENERAL REVISION	DDG	EAR	 <p>Macroflex Slovakia sro. Mikovíniho 4 917 01 Trnava www.macroflex.sk</p> <p>+421 33 5936 159 +421 33 5936 237 +421 903 447 575 macroflex@macroflex.sk</p>
0	21/09/81	INFORMATION	JRS	EAR	
REV.	DATE	 <p>pihasa pipe hanger solutions</p>	DRAW.	REV.	

BRONZO-GRAFITOVÉ KLZNÉ DOSKY

FIG.: 2139

SEKCIA B
16

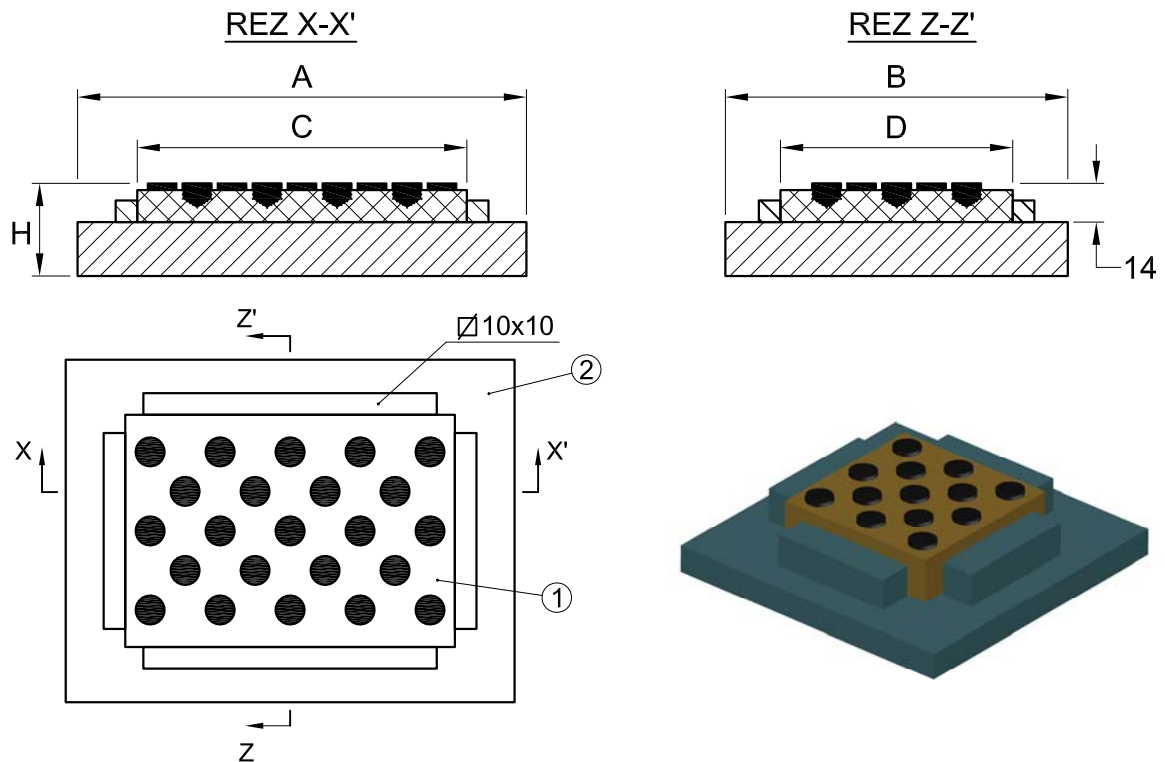

No.	A (mm)	B (mm)	C (mm)	D (mm)	H (mm)	POČET DOSIEK	ZAŤAŽENIE (kN)
01	90	90	50	50	22	1	37,5
02	115	90	75	50	22	1	56,25
03	140	90	100	50	22	1	75,00
04	190	90	150	50	22	1	112,50
05	115	115	75	75	22	1	84,35
06	140	115	100	75	22	1	112,50
07	190	115	150	75	22	1	168,75
08	240	115	200	75	22	1	225,00
09	340	115	300	75	22	2	337,50
10	140	140	100	100	24	1	150,00
11	190	140	150	100	24	1	225,00
12	240	140	200	100	24	1	300,00
13	340	140	300	100	24	2	450,00
14	190	190	150	150	24	1	337,50
15	240	190	200	150	24	1	450,00
16	340	190	300	150	24	2	675,00
17	440	190	400	150	24	2	900,00
18	240	240	200	200	26	1	600,00
19	340	240	300	200	26	2	900,00
20	440	240	400	200	26	2	1.200,00
21	540	240	500	200	26	3	1.500,00







- ① Bronzová doska s grafitovými klznými segmentami.
 ② základná doska z uhlíkovej ocele a rámikom z profilu 10 x 10 mm na fixáciu klznej dosky.

POZNÁMKA:

- klzné dosky sa inštalujú navarením základovej dosky na oceľovú konštrukciu
- klzné dosky môžu byť dodané v rôznych rozmeroch a hrúbkach, minimálna celková hrúbka ≥ 15 mm
- pracovná teplota až do 600°C

- Doplnky:

- * klzné dosky môžu byť dodané s obmedzovačmi pohybu
- * valcové alebo sférické klzné dosky umožňujúce uhlovú výchylku
- * špeciálne doplnky podľa požiadaviek zákazníka

1	21/07/10	GENERAL REVISION	DDG	EAR	 Macroflex Slovakia sro.  +421 33 5936 159 Mikovíniho 4  +421 33 5936 237 917 01 Trnava  +421 903 447 575 www.macroflex.sk  macroflex@macroflex.sk
0	20/10/98	INFORMATION	JB	EAR	
REV.	DATE	 pihasa <small>pipe hanger solutions</small>	DRAW.	REV.	

BRONZO-GRAFITOVÉ KLZNÉ DOSKY SFÉRICKÉ

FIG.: 2139
SPH

SEKCIA B
17

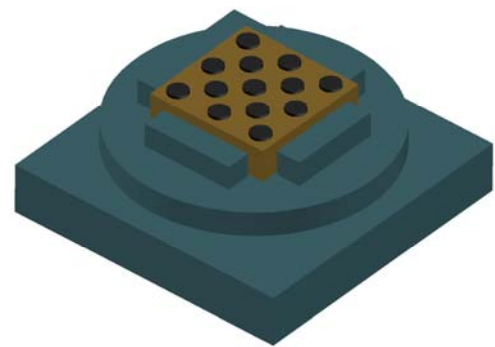
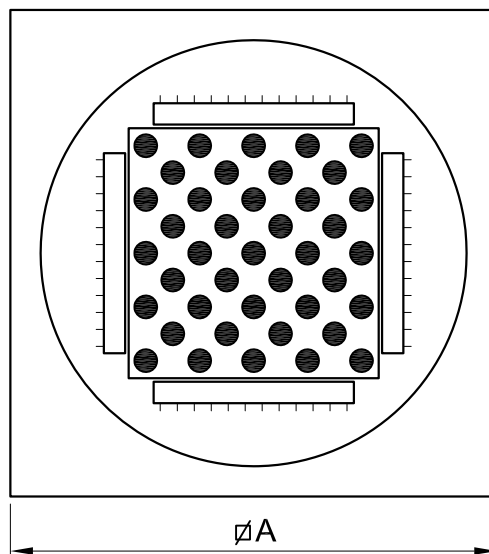
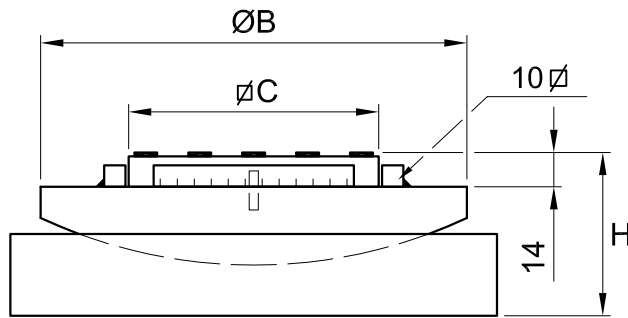

No.	ØA (mm)	ØB (mm)	ØC (mm)	H (mm)	ZAŤAŽENIE (kN)
1	100	90	50	39	22,50
2	130	120	75	42	50,5
3	170	160	100	50	90,0
4	200	190	120	54	127,5
5	240	230	150	61	200,00

POZNÁMKA:

- maximálny náklon vo všetkých smeroch +/- 2°
- podľa požiadavky môže byť náklon zväčšený avšak na úkor rozmerov uloženia

0	21/07/10	GENERAL REVISION	DDG	EAR
REV.	DATE	 pihasa pipe hanger solutions	DRAW.	REV.



Macroflex Slovakia sro.
Mikovániho 4
917 01 Trnava
www.macroflex.sk



+421 33 5936 159
+421 33 5936 237
+421 903 447 575
macroflex@macroflex.sk

NAVAROVACÍ STRMEŇ PRIEMER $\emptyset \leq \text{DN } 150$

FIG.: 2250

SEKCIA B
18

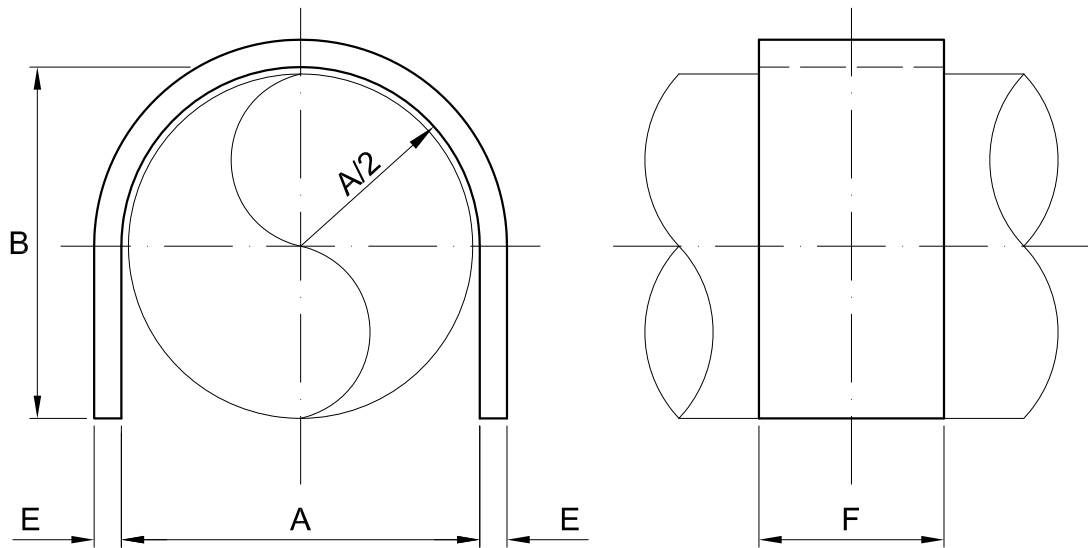

DN	A (mm)	B (mm)	E (mm)	F (mm)	HMOTN. (kg)	MAX. DOPORUČENÉ LATERÁLNE ZAŤAŽENIE (kN)
15	23	23	6	30	0,1	15,0
20	28	28	6	30	0,12	15,0
25	35	35	6	40	0,2	20,0
32	44	43	6	40	0,25	20,0
40	50	49	8	50	0,45	25,0
50	62	61	8	50	0,55	25,0
65	75	74	8	50	0,7	25,0
80	91	90	10	60	1,2	30,0
100	117	116	10	60	1,5	30,0
125	145	144	10	60	1,9	30,0
150	172	171	12	70	3,1	37,5

POUŽITIE: pre vedenie izolovaných potrubí.

OBJEDNÁVANIE:

- typ
- Fig.
- priemer potrubia.

POZNÁMKA:

- možnosť výroby väčších priemerov (neodporúča sa)
- vertikálne orientované zaťaženia sú oveľa väčšie, než je uvedené bočné zaťaženie (nie menej ako 4 krát, než je uvedené)
- tolerancia na úrovniach A a B $\begin{matrix} +1,5 \\ -0 \end{matrix}$

0	03/02/12	GENERAL REVISION	DDG	EAR
REV.	DATE	 pihasa pipe hanger solutions	DRAW.	REV.



Macroflex Slovakia sro.  +421 33 5936 159
Mikovíniho 4  +421 33 5936 237
917 01 Trnava  +421 903 447 575
www.macroflex.sk  macroflex@macroflex.sk

KOTEVNÝ STRMEŇ

FIG.: 2251

SEKCIA B
19

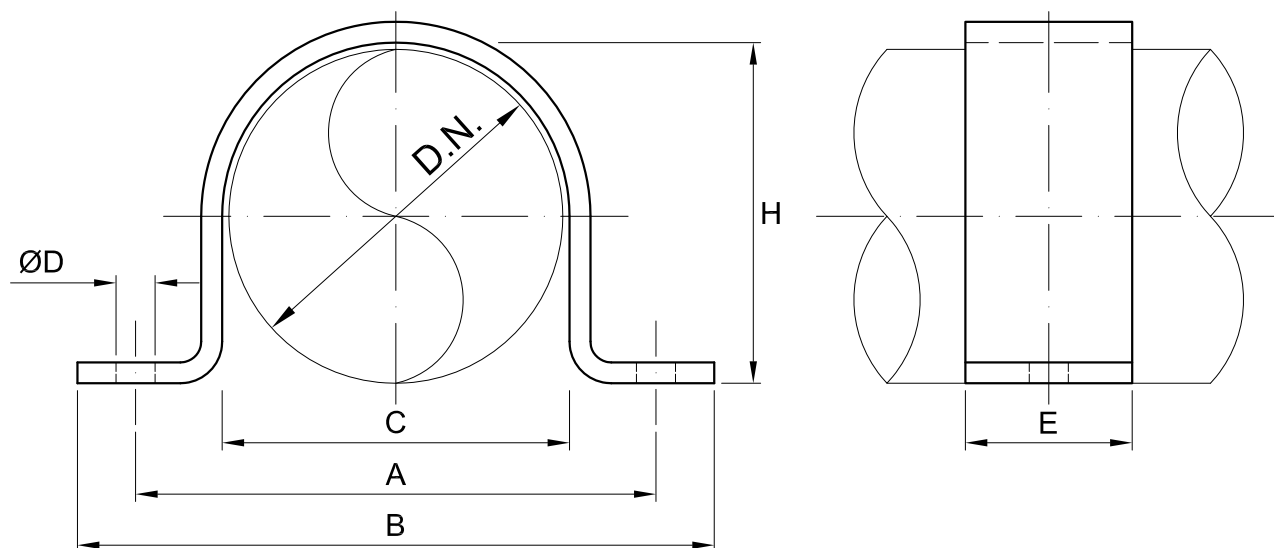

No.	D.N.	A (mm)	B (mm)	C (mm)	ØD (mm)	E (mm)	H (mm)	HMOTN. (kg)
1	15	70	110	25	11,5	30	23	0,18
2	20	75	115	31	11,5	30	29	0,2
3	25	85	135	38	11,5	35	35	0,28
3 a	32	95	145	47	11,5	35	44	0,32
4	40	110	170	53	13,5	60	50	0,65
5	50	140	200	65	13,5	60	62	0,8
6	65	155	215	77	13,5	60	75	0,9
7	80	170	240	93	15,5	60	91	1
8	100	196	266	118	15,5	60	116	1,6
8 a	125	222	292	146	15,5	60	144	1,8
9	150	250	320	174	15,5	60	171	2,1
10	200	312	382	225	17,5	60	222	2,7
11	250	375	445	279	17,5	80	276	5,3
12	300	416	486	330	17,5	80	327	6,2
13	350	460	530	362	19,5	80	359	8,5
14	400	514	584	412	19,5	80	409	9,2
15	450	565	635	463	19,5	80	460	10,5
16	500	617	687	514	19,5	80	511	11,5







POUŽITIE: pre vedenie potrubí v radoch na zemi alebo na konštrukcii

MATERIAL: uhlíková oceľ, legovaná oceľ, nerezavajúca oceľ

OBJEDNÁVANIE:

- typ
- Fig.
- priemer potrubia

POZNÁMKA: podľa požiadavky môžu byť vyrobené iné priemery, špeciálne alebo väčšie ako je štandard.

1	21/07/10	GENERAL REVISION	DDG	EAR	 <p>Macroflex Slovakia sro. Mikovíniho 4 917 01 Trnava www.macroflex.sk</p>	   	<p>+421 33 5936 159 +421 33 5936 237 +421 903 447 575 macroflex@macroflex.sk</p>
0	21/09/81	INFORMATION	JRS	EAR			
REV.	DATE	 <p>pihasa pipe hanger solutions</p>	DRAW.	REV.			

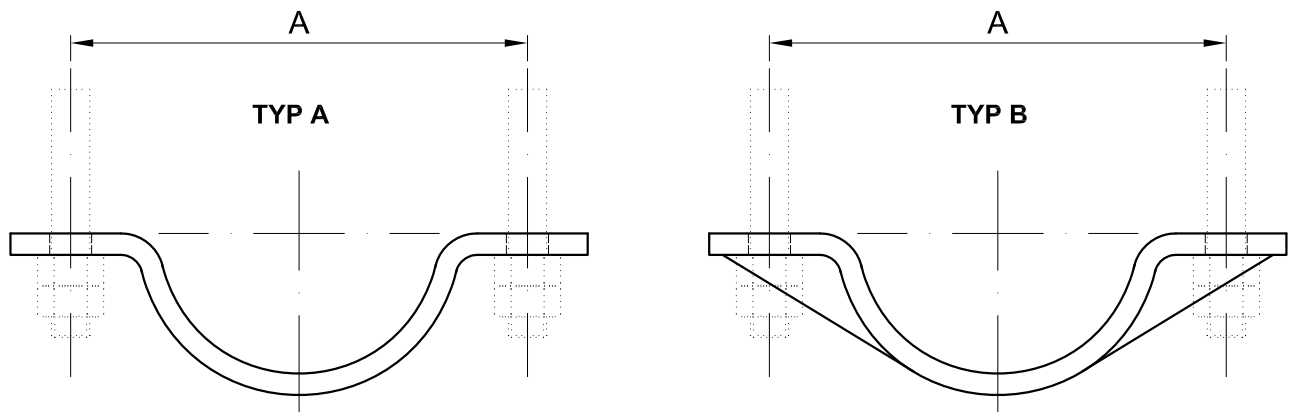

POUŽITIE: zavesenie horizontálnych potrubí pomocou závitových tyčí. Vyžaduje dostatok priestoru medzi konštrukciou a potrubím.

TYPY:

"TYP A" - polobjímka bez výstuhu.

"TYP B" - polobjímka s bočnými výstuhami.

SPÔSOB VÝBERU: podľa obrázku na nasledujúcej strane. Na obrázku je požadovaná veľkosť pásu v závislosti zaťaženia a vzdialenosti medzi závesnými tyčami. Platí pre polobjímky z uhlíkovej ocele až do teploty 300°C.







1° - vhodný profil potrubnej objímky najdete v priesečníku požadovanej vzdialenosti osí tyčí a maximálneho zaťaženia.

2° - údaj o zaťažení je určujúci aj pre priemer závitových tyčí.

MATERIÁL: uhlíková oceľ, legovaná oceľ a nerezavajúca oceľ.

OBJEDNÁVANIE:

- typ.
- Fig.č.
- priemer potrubia.
- vzdialenosť medzi osami vonkajších skrutiek (level "A").
- zaťaženie.
- prevádzková teplota potrubia.

1	21/07/10	GENERAL REVISION	DDG	EAR	 <p>Macroflex Slovakia sro.  +421 33 5936 159 Mikovíniho 4  +421 33 5936 237 917 01 Trnava  +421 903 447 575 www.macroflex.sk  macroflex@macroflex.sk</p>
0	21/09/81	INFORMATION	JRS	EAR	
REV.	DATE	 <p>pihasa pipe hanger solutions</p>	DRAW.	REV.	

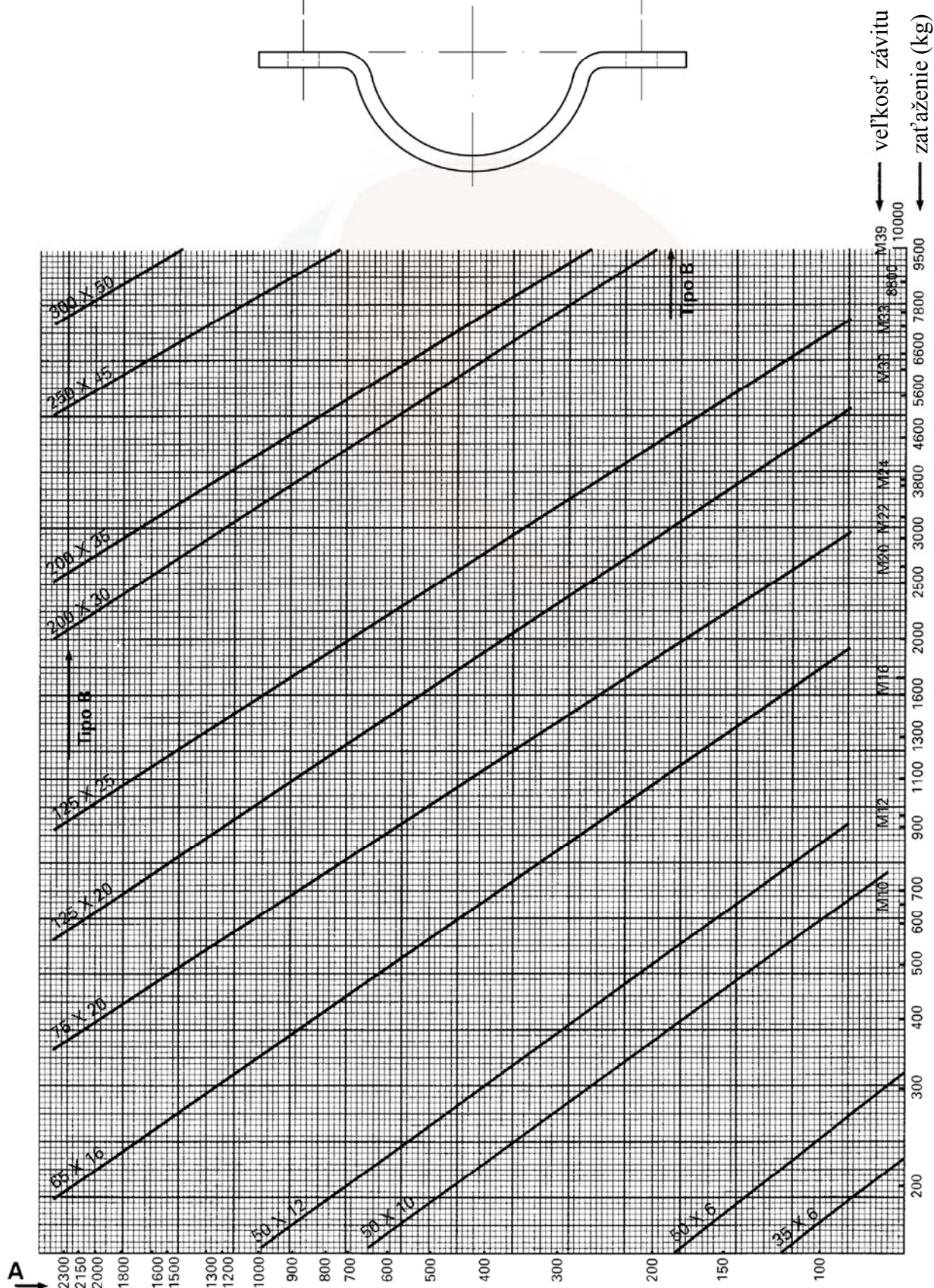
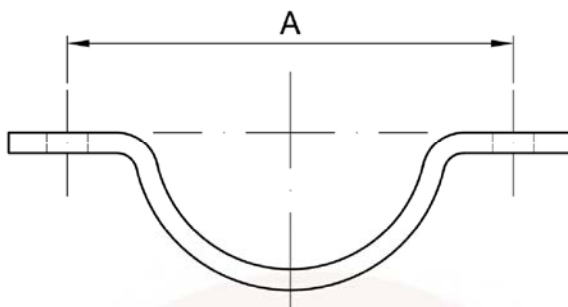

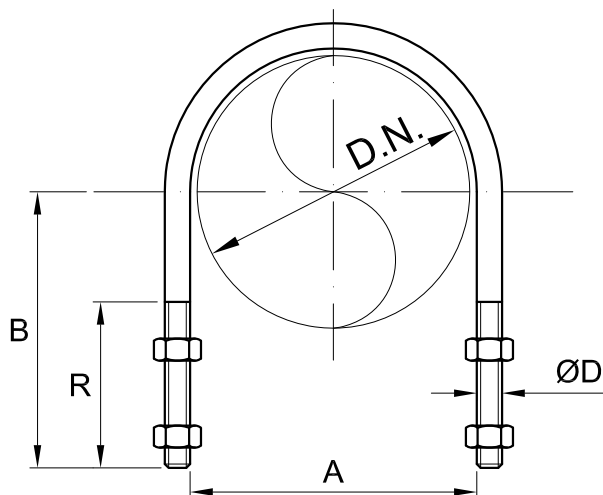

veľk.	DN	A (mm)	B (mm)	R (mm)	ZÁVIT	HMOTN. (kg)	MAX. ZAŤAŽENIE (kN)
1	15	24	40	35	M6	0,04	3,00
2	20	29	45	40	M6	0,05	3,00
3	25	36	50	40	M8	0,07	5,00
3 a	32	45	50	40	M8	0,09	5,00
4	40	51	55	45	M10	0,17	7,00
5	50	64	70	55	M10	0,2	7,00
6	65	76	80	65	M12	0,3	10,00
7	80	92	90	65	M12	0,4	10,00
8	100	118	115	75	M12	0,5	10,00
8 a	125	145	135	85	M12	0,7	10,00
9	150	172	155	95	M16	1,1	22,00
10	200	223	180	95	M16	1,5	22,00
11	250	277	215	100	M20	2,5	35,00
12	300	328	245	105	M24	4,2	50,00
13	350	360	260	105	M24	4,5	50,00
14	400	411	285	105	M24	5,0	50,00
15	450	462	320	120	M24	5,5	50,00
16	500	512	350	120	M24	6,0	50,00
17	600	614	400	120	M24	7,0	50,00
18	700	766	475	120	M24	8,0	50,00







POUŽITIE: upevnenie potrubia ku konštrukciám. Platí pre neizolované potrubia za nízkeho priečneho zaťaženia (maximálne 30% z nominálneho zvislého zaťaženia).

MATERIAL: uhlíková oceľ a nehrdzavejúca oceľ

OBJEDNÁVANIE:

- typ
- Fig.č.
- priemer potrubia.

POZNÁMKA: možnosť výroby v iných rozmeroch ako je štandard.

1	21/07/10	GENERAL REVISION	DDG	EAR	 Macroflex Slovakia sro. Mikovíniho 4 917 01 Trnava www.macroflex.sk	 +421 33 5936 159  +421 33 5936 237  +421 903 447 575  macroflex@macroflex.sk
0	21/09/81	INFORMATION	JRS	EAR		
REV.	DATE	 pihasa <small>pipe hanger solutions</small>	DRAW.	REV.		

STRMEŇ Z KRUHOVEJ OCELE ĽAHKÝ (LIGHT)

FIG.: 2281

SEKCIA B
23

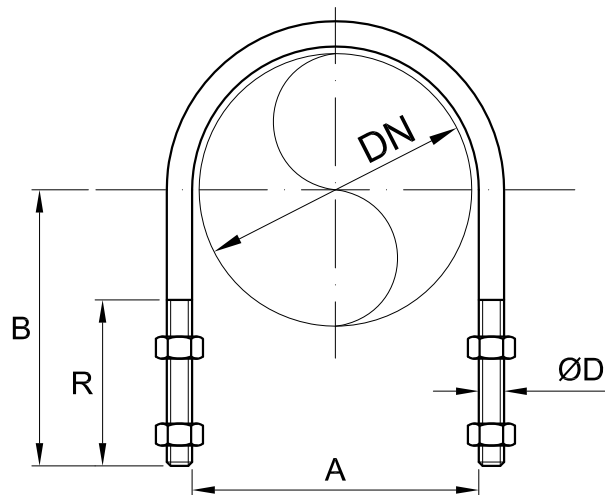

veľk.	DN	A (mm)	B (mm)	R (mm)	Závit	HMOTN. (kg)	MAX. ZAŤAŽENIE (kN)
1	15	24	30	22	M6	0,03	2,50
2	20	29	35	24	M6	0,03	2,50
3	25	36	44	29	M6	0,04	2,50
3 a	32	45	49	29	M6	0,05	2,50
4	40	51	54	32	M8	0,08	3,50
5	50	64	59	32	M8	0,09	3,50
6	65	76	79	43	M10	0,18	5,50
7	80	92	84	43	M10	0,20	5,50
8	100	118	95	43	M10	0,24	5,50
8 a	125	145	113	48	M10	0,28	5,50
9	150	172	126	48	M10	0,31	5,50
10	200	223	152	48	M10	0,38	5,50
11	250	277	179	48	M10	0,45	5,50
12	300	328	214	60	M12	0,75	10,50
13	350	360	229	60	M12	0,80	10,50
14	400	411	264	70	M12	0,90	10,50
15	450	462	296	80	M12	1,9	11,50
16	500	512	324	80	M12	2,1	11,50

POUŽITIE: upevnenie potrubia ku konštrukciám.

MATERIAL: uhlíková oceľ a nehrdzavejúca oceľ

ORDER FORM:

- typ
- Fig.č.
- priemer potrubia.

POZNÁMKA: možnosť výroby v iných rozmeroch ako je štandard.

1	21/07/10	GENERAL REVISION	DDG	EAR
0	21/09/81	INFORMATION	JRS	EAR
REV.	DATE	 pihasa pipe hanger solutions	DRAW.	REV.



Macroflex Slovakia sro.
Mikovíniho 4
917 01 Trnava
www.macroflex.sk



+421 33 5936 159
+421 33 5936 237
+421 903 447 575
macroflex@macroflex.sk

TYP A

(závesné so strmeňom)

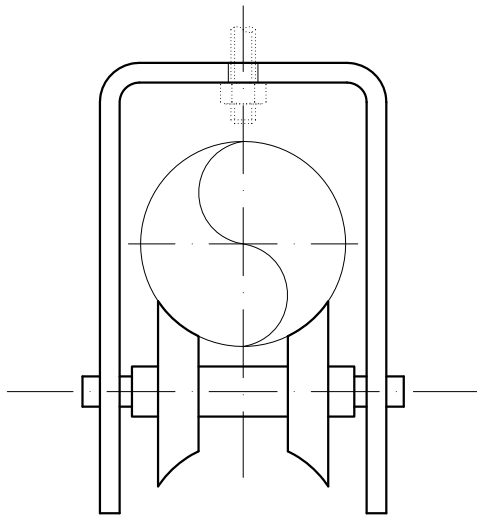

TYP B

(na základovej doske)

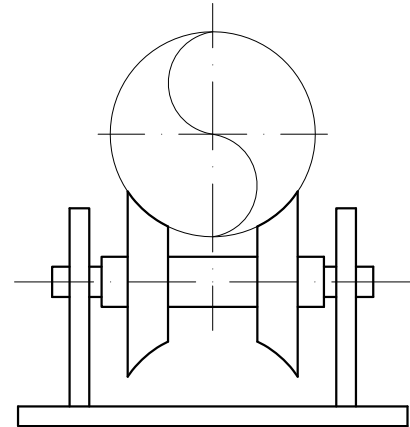

TYP C

(závesné s tyčami)

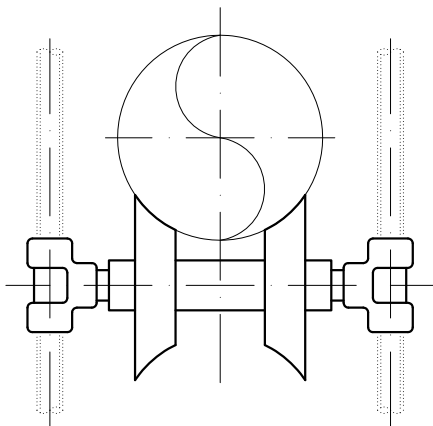

TYP D

(závesné s pružinami)

No.	1	2	3
Zaťaž. (kN)	4,00	13,00	30,00

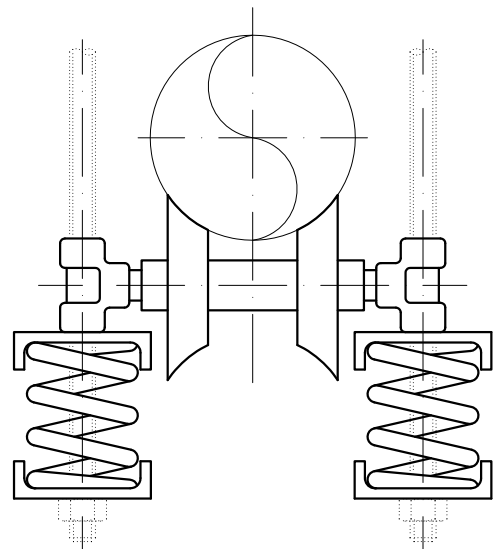

POUŽITIE: umožniť axiálny pohyb v dôsledku tepelnej dilatácie potrubia.

OBJEDNÁVANIE:

- typ
- Fig.č.
- zaťaženie
- priemer potrubia

POZNÁMKA: najvhodnejšie valčkové uloženie Vám ponúkame na základe zadaných zaťažení, pohybov a rozmerov potrubia

1	21/07/10	GENERAL REVISION	DDG	EAR
0	21/09/81	INFORMATION	JRS	EAR
REV.	DATE		DRAW.	REV.



Macroflex Slovakia sro.
Mikovíniho 4
917 01 Trnava
www.macroflex.sk



+421 33 5936 159
+421 33 5936 237
+421 903 447 575
macroflex@macroflex.sk

Typ N

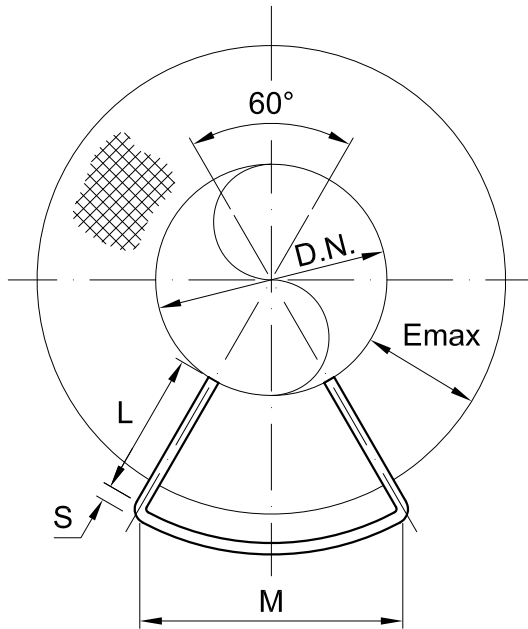

Typ W

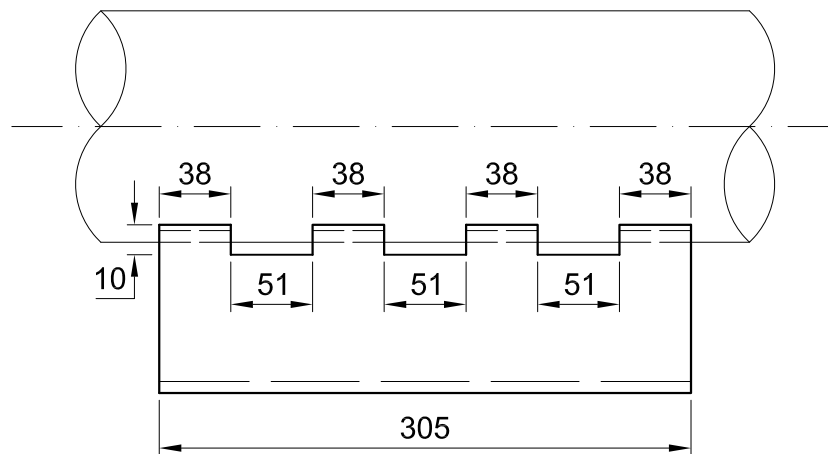
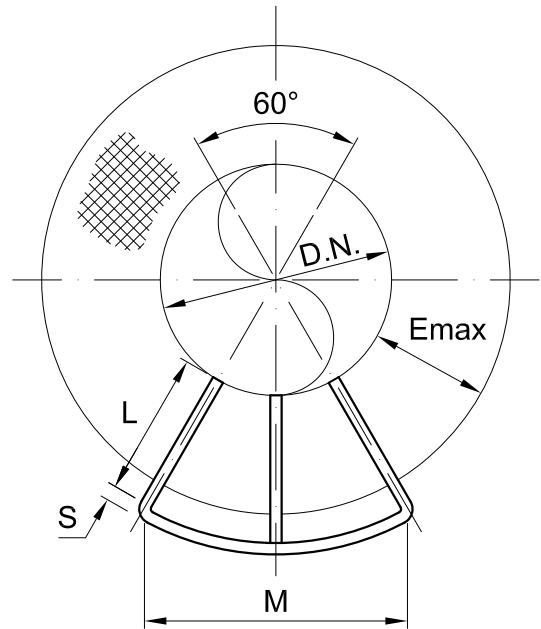

POUŽITIE: pre vedenie potrubia s izoláciou

OBJEDNÁVANIE:

- typ
- Fig.č.
- priemer potrubia

1	21/07/10	GENERAL REVISION	DDG	EAR
0	21/09/81	INFORMATION	JRS	EAR
REV.	DATE		DRAW.	REV.



Macroflex Slovakia sro.
Mikovíniho 4
917 01 Trnava
www.macroflex.sk



+421 33 5936 159
+421 33 5936 237
+421 903 447 575
macroflex@macroflex.sk

POTRUBNÉ SEDLÁ

**FIG.: 2300
2304**

**SEKCIA B
26**

FIG. 2300 - Typ N - hr. izolácie 25 mm

Typ.	DN	E _{max.} (mm)	L (mm)	M (mm)	S (mm)	MAX. ZAŤAŽENIE (kN)
1	20	25	26	40	4	5,25
2	25	25	28	45	4	5,25
3	40	25	28	53	4	5,25
4	50	25	28	59	4	5,25
5	65	25	28	66	5	5,25
6	80	25	28	75	5	5,25
7	100	25	28	86	6	8,00
8	150	25	32	117	6	8,00

FIG. 2301 - Typ N - hr. izolácie 40 mm

Typ.	DN	E _{max.} (mm)	L (mm)	M (mm)	S (mm)	MAX. ZAŤAŽENIE (kN)
1	20	40	41	55	4	5,25
2	25	40	43	60	4	5,25
3	40	40	43	68	4	5,25
4	50	40	43	74	4	5,25
5	65	40	43	81	6	5,25
6	80	40	43	90	6	8,00
7	100	40	43	101	6	8,00
8	150	40	43	128	6	8,00
9	200	40	44	154	6	8,00

FIG. 2302 - Typ W - hr. izolácie 40 mm

Typ.	DN	E _{max.} (mm)	L (mm)	M (mm)	S (mm)	MAX. ZAŤAŽENIE (kN)
1	250	40	45	182	10	8,00
2	300	40	50	213	10	22,50
3	325	40	45	223	12	22,50
4	400	40	50	254	12	22,50
5	450	40	46	269	12	22,50
6	500	40	46	301	15	32,50
7	600	40	46	351	15	32,50
8	700	40	46	426	15	32,50
9	800	40	46	503	15	32,50

FIG. 2303 - Typ N - hr. izolácie 50 mm

Typ.	DN	E _{max.} (mm)	L (mm)	M (mm)	S (mm)	MAX. ZAŤAŽENIE (kN)
1	20	50	51	65	4	5,25
2	25	50	53	70	4	5,25
3	40	50	53	78	5	8,00
4	50	50	53	84	6	8,00
5	65	50	53	91	6	8,00
6	80	50	55	100	6	8,00
7	100	50	55	114	6	8,00
8	150	50	57	142	6	8,00
9	200	50	54	164	8	8,00

FIG. 2304 - Typ W - hr. izolácie 50 mm

Typ.	DN	E _{max.} (mm)	L (mm)	M (mm)	S (mm)	MAX. ZAŤAŽENIE (kN)
1	250	50	55	192	10	22,50
2	300	50	60	223	10	22,50
3	325	50	55	233	12	22,50
4	400	50	60	264	12	22,50
5	450	50	51	276	15	32,50
6	500	50	56	311	15	32,50
7	600	50	56	361	15	32,50
8	700	50	56	436	15	32,50
9	800	50	56	513	20	32,50

REV.	DATE		DRAW.	REV.
1	21/07/10	GENERAL REVISION	DDG	EAR
0	21/09/81	INFORMATION	JRS	EAR

pihasa
pipe hanger solutions



Macroflex Slovakia sro.
Mikovíniho 4
917 01 Trnava
www.macroflex.sk



+421 33 5936 159
+421 33 5936 237
+421 903 447 575
macroflex@macroflex.sk

POTRUBNÉ SEDLÁ

**FIG.: 2305
2310**

**SEKCIA B
27**

FIG. 2305 - Typ N - hr. izolácie 65 mm

Typ.	DN	E _{max.} (mm)	L (mm)	M (mm)	S (mm)	MAX. ZAŤAŽENIE (kN)
1	40	65	68	93	5	8,00
2	50	65	68	99	5	8,00
3	65	65	68	106	6	8,00
4	80	65	68	113	6	8,00
5	100	65	68	126	6	8,00
6	150	65	70	157	8	8,00
7	200	65	70	179	8	8,00

FIG. 2306 - Typ W - hr. izolácie 65 mm

Typ.	DN	E _{max.} (mm)	L (mm)	M (mm)	S (mm)	MAX. ZAŤAŽENIE (kN)
1	250	65	70	207	12	22,50
2	300	65	76	239	12	22,50
3	350	65	71	250	12	22,50
4	400	65	71	276	15	32,50
5	450	65	66	291	15	32,50
6	500	65	71	326	15	32,50
7	600	65	71	376	15	32,50
8	750	65	71	451	20	32,50
9	900	65	71	528	20	32,50

FIG. 2307 - Typ N - hr. izolácie 75 mm

Typ.	DN	E _{max.} (mm)	L (mm)	M (mm)	S (mm)	MAX. ZAŤAŽENIE (kN)
1	50	75	78	109	5	8,00
2	65	75	78	116	5	8,00
3	75	75	80	125	5	8,00
4	100	75	78	136	6	8,00
5	150	75	82	167	8	8,00
6	200	75	79	189	8	8,00

FIG. 2308 - Typ W - hr. izolácie 75 mm

Typ.	DN	E _{max.} (mm)	L (mm)	M (mm)	S (mm)	MAX. ZAŤAŽENIE (kN)
1	250	75	81	218	12	22,50
2	300	75	86	249	12	22,50
3	350	75	80	258	12	22,50
4	400	75	82	286	15	32,50
5	450	75	76	301	15	32,50
6	500	75	81	336	15	32,50
7	600	75	81	386	20	32,50
8	750	75	81	461	20	32,50
9	900	75	81	538	20	32,50

FIG. 2309 - Typ N - hr. izolácie 100 mm

Typ.	DN	E _{max.} (mm)	L (mm)	M (mm)	S (mm)	MAX. ZAŤAŽENIE (kN)
1	100	100	103	161	8	8,00
2	150	100	108	193	8	8,00
3	200	100	104	214	8	8,00

FIG. 2310 - Typ W - hr. izolácie 100 mm

Typ.	DN	E _{max.} (mm)	L (mm)	M (mm)	S (mm)	MAX. ZAŤAŽENIE (kN)
1	250	100	106	243	12	22,50
2	300	100	111	274	12	22,50
3	350	100	102	280	15	32,50
4	400	100	107	311	20	32,50
5	450	100	101	326	20	32,50
6	500	100	106	361	20	32,50
7	600	100	106	411	20	32,50
8	750	100	106	486	20	32,50
9	900	100	106	563	20	32,50

1	21/07/10	GENERAL REVISION	DDG	EAR
0	21/09/81	INFORMATION	JRS	EAR
REV.	DATE	 pihasa pipe hanger solutions	DRAW.	REV.

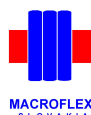

Macroflex Slovakia sro.  +421 33 5936 159
Mikovíniho 4  +421 33 5936 237
917 01 Trnava  +421 903 447 575
www.macroflex.sk  macroflex@macroflex.sk